

SCHEDA TECNICA

Linea Avana

Cartelle sospese realizzate in cartoncino manilla 220 gr/mq. color avana.

Aste di sospensione in filo d'acciaio armonico con ganci di scorrimento in polystirene nero.

Portaetichette in plastica trasparente ad effetto lenticolare dotato di sistema di collegamento in continuo delle cartelle.

Fondo a V oppure rinforzato in cartoncino pesante nero da 400 gr./mq. nella versione ad U 3 cm.

Nei modelli per armadio l'incavo frontale agevola l'inserimento/prelievo dei documenti

Etichette con bordo colorato per l'immediato reperimento dei fascicoli.





Confezione 50 p.zi – Colore avana

Cod. 060/330 Beta –B1

Aste di sospensione: filo d'acciaio;
Cartone: manilla 220 g/m²;
Confezione: 50 p.zi;

AVANA

Portacartellino: 290mm;
Colore: avana;
Fondo: a V.





Immagine Prodotto	Schema Prodotto	
		A: 330mm.
		B: 245mm.
		C: 310mm.
		D: 0mm.

Cod. 060/330 Beta 3 –B1

Aste di sospensione: filo d'acciaio;
Cartone: manilla 220 g/m²;
Confezione: 50 p.zi;



Portacartellino: 290mm;
Colore: avana;
Fondo: U 30 mm.





Immagine Prodotto	Schema Prodotto	
		A: 330mm.
		B: 245mm.
		C: 310mm.
		D: 30mm.

Cod. 060/390 Beta -B1

Aste di sospensione: filo d'acciaio;
Cartone: manilla 220 g/m²;
Confezione: 50 p.zi;

AVANA

Portacartellino: 290mm;
Colore: avana;
Fondo: a V.

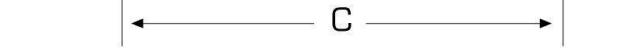

Immagine Prodotto	Schema Prodotto	
		A: 390mm.
		B: 245mm.
		C: 370mm.
		D: 0mm.

Cod. 060/390 Beta 3 –B1

Aste di sospensione: filo d'acciaio;
Cartone: manilla 220 g/m²;
Confezione: 50 p.zi;

AVANA

Portacartellino: 290mm;
Colore: avana;
Fondo: U 30 mm.

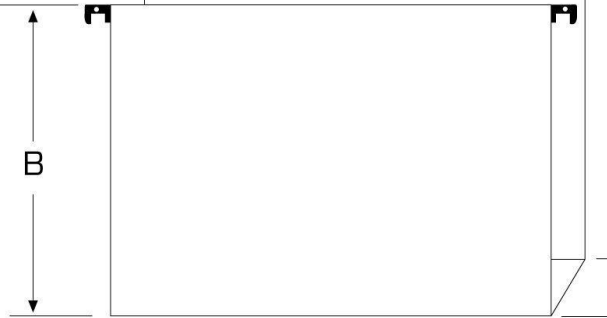
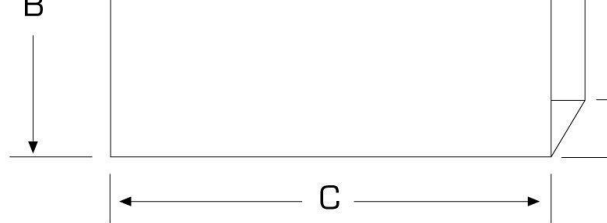
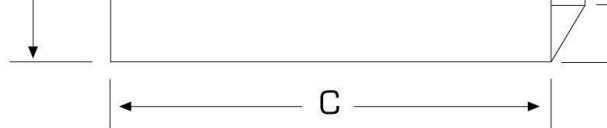
Immagine Prodotto	Schema Prodotto	
		A: 390mm.
		B: 245mm.
		C: 370mm.
		D: 30mm.

Cod. 064 F Beta -B1

Aste di sospensione: filo d'acciaio;
Cartone: manilla 220 g/m²;
Confezione: 50 p.zi;

AVANA

Portacartellino: 140mm;
Colore: avana;
Fondo: V

Immagine Prodotto



Schema Prodotto

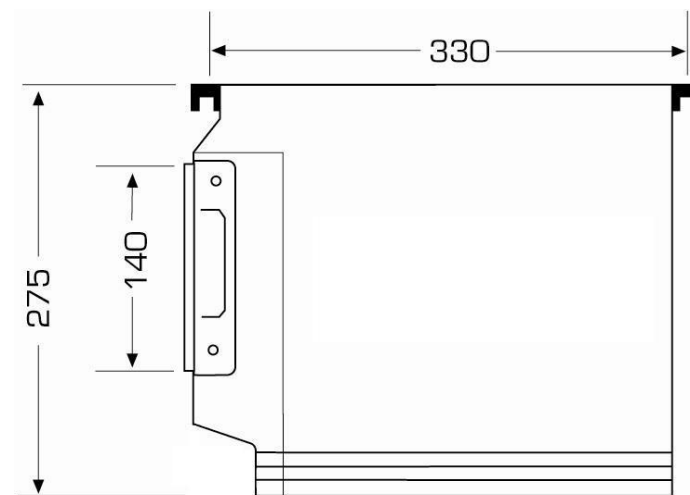

Cod. 064 F Beta 3 –B1

Aste di sospensione: filo d'acciaio;
Cartone: manilla 220 g/m²;
Confezione: 50 p.zi;

AVANA

Portacartellino: 140mm;
Colore: avana;
Fondo: U 30 mm.

Immagine Prodotto



Schema Prodotto

